



Acessórios de pressão PVC-U

Joelho 45° colar rm

ITEM 200

REFERÊNCIA	DESCRIÇÃO	Peso líquido	Volume (m ³)	Peso bruto	Unidades por lote
1002152	Joelho 45° ENCOLAR-R/M JUNTA 32-1"	0,0422	0,01553	4,4804	100
1002153	Joelho 45° ENCOLAR-R/M JUNTA 40-1 1/4"	0,0764	0,02244	5,07	60
1002154	Joelho 45° ENCOLAR-R/M JUNTA 50-1 1/2"	0,1232	0,02244	4,184	30
1002155	Joelho 45° ENCOLAR-R/M JUNTA 63-2"	0,1975	0,03129	6,4219	30
1002156	Joelho 45° ENCOLAR-R/M JUNTA 75-2 1/2"	0,34494	0,04717	10,99	30



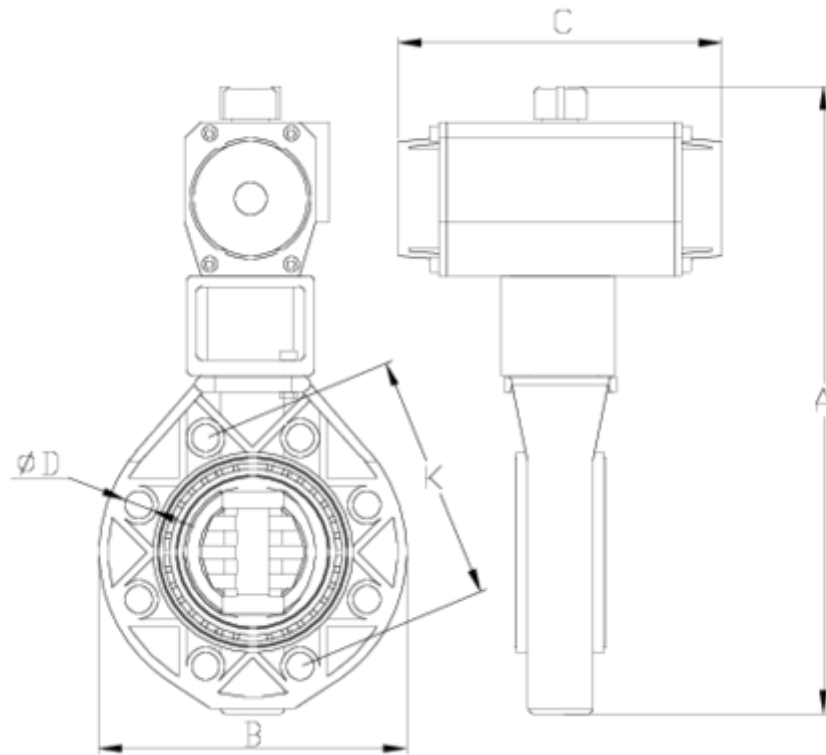

ITEM 200 | Joelho 45° colar rm

CÓDIGO	A x a	PESO (g)	C	D	E	F	PN	MEDIDA
02152	32x1"	52	54	19	19	57	PN10	BSP
02153	40x1 1/4"	81	62	22	21	85	PN10	BSP
02154	50x1 1/2"	124	85	26	22	94	PN10	BSP
02155	63x2"	226	102	31	26	109	PN10	BSP
02156	75x2 1/2"	330	131	45	29	115	PN10	BSP





Documentación del Producto



Certificados del Producto



Certificados de la Empresa

